

EKB1677 - 18W; 1750lm; 4000K

**E light**  
by eko-light

EKO-LIGHT TEAM SP. Z O.O.  
UL. GŁÓWNA 142, 42-280  
CZĘSTOCHOWA, POLAND

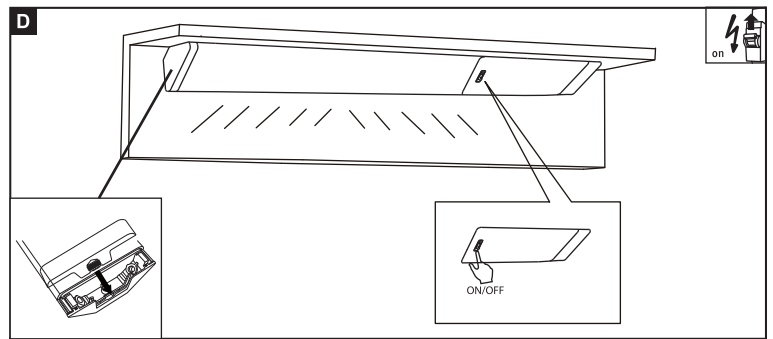
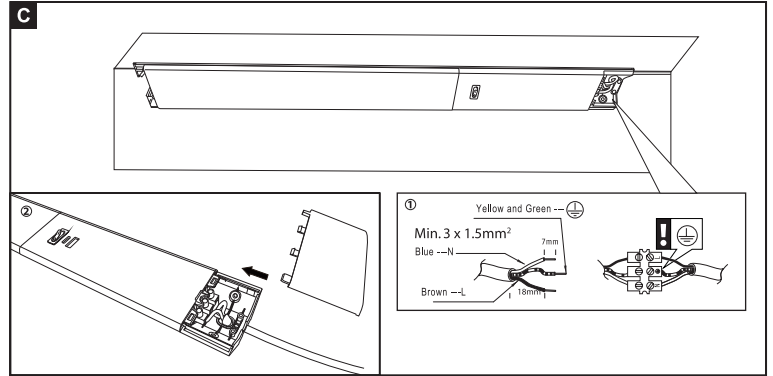
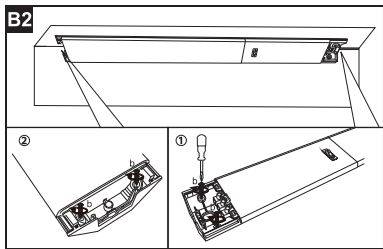
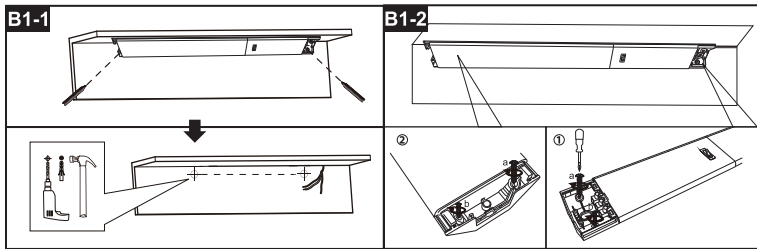
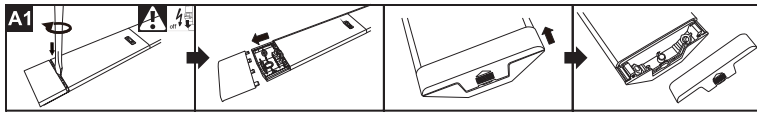
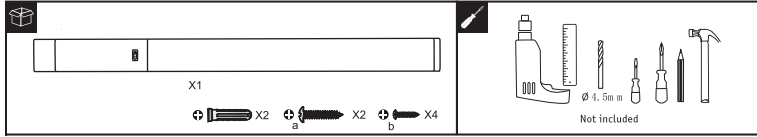

### Demontaż źródła światła

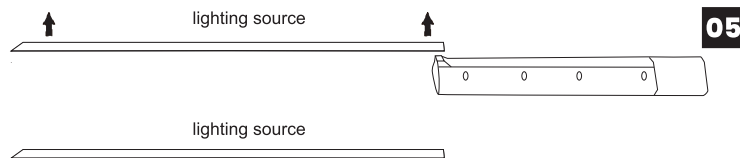
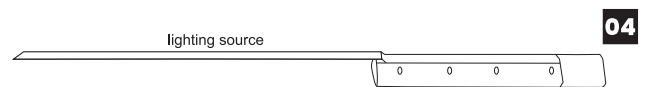
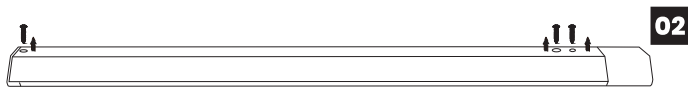
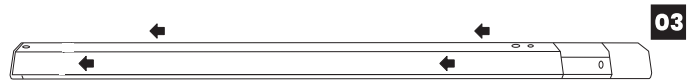

www.eko-light.com

biuro@eko-light.com

Phone: +48 666 503 333

