

# EKB6592

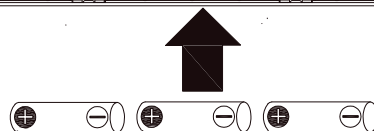

EKO-LIGHT TEAM SP. Z O.O. [W] [www.eko-light.com](http://www.eko-light.com)  
UL. GŁÓWNA 142, 42-280 [M] [biuro@eko-light.com](mailto:biuro@eko-light.com)  
CZĘSTOCHOWA, POLAND [P] +48 666 503 666

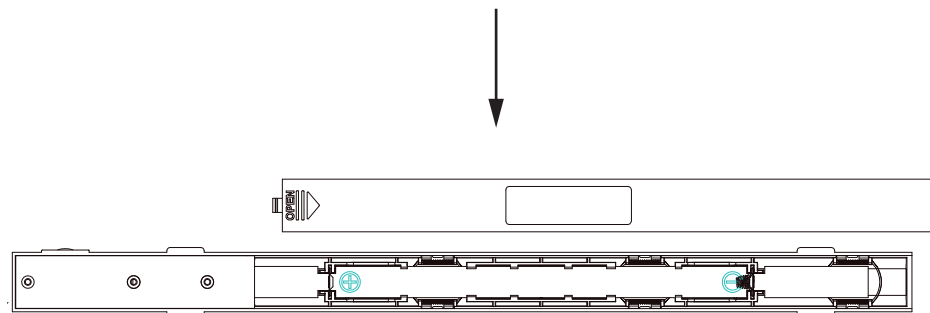
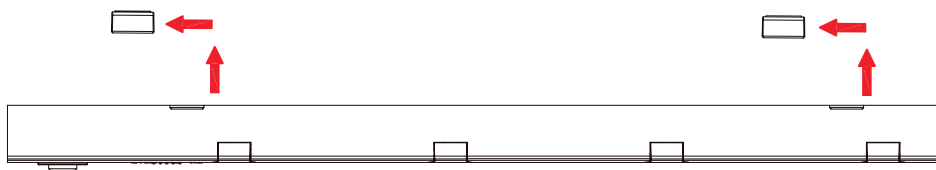
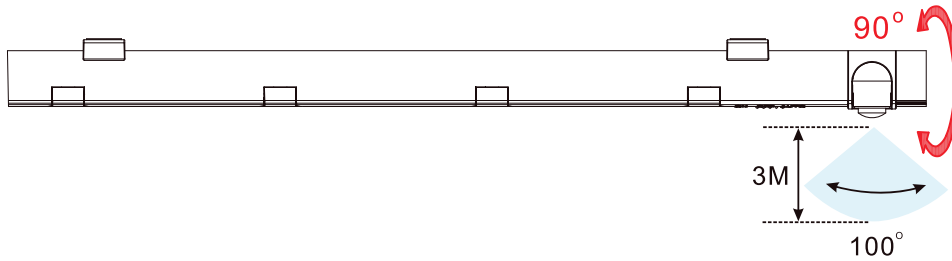
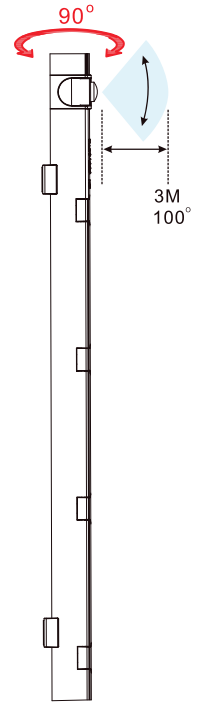
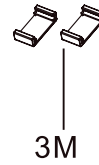
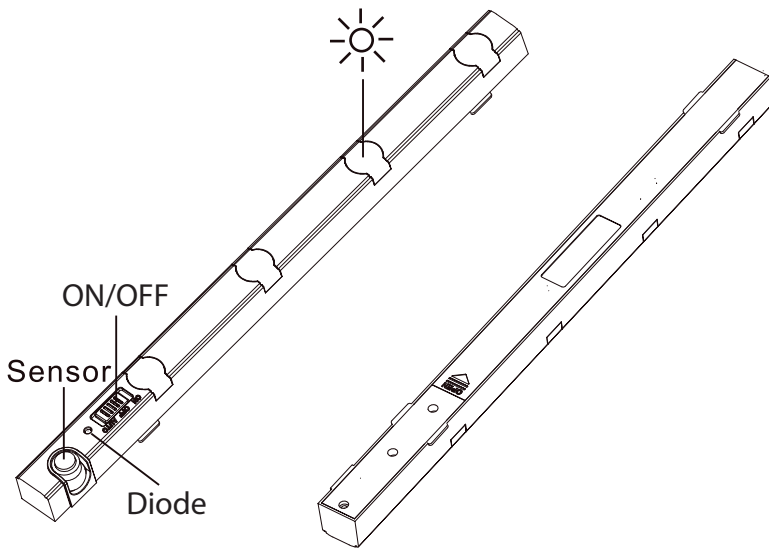

3xAAA  
(Not included)

