

SPARTA MLP6512

MILAGRO®

Brand that inspires

EKO-LIGHT TEAM SP. Z O.O. [W] www.eko-light.com
UL. GŁÓWNA 142, 42-280 [M] biuro@eko-light.com
CZĘSTOCHOWA, POLAND [P] +48 666 503 666

01



02

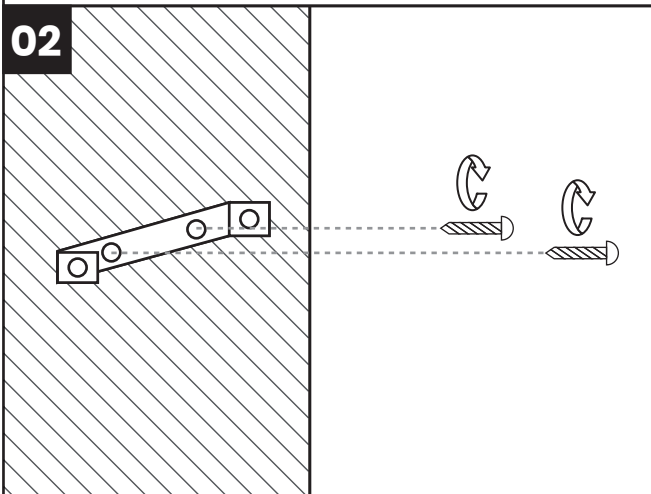

03

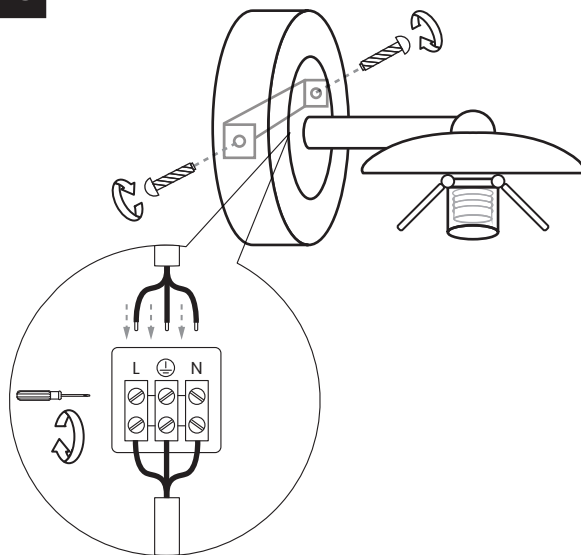

04

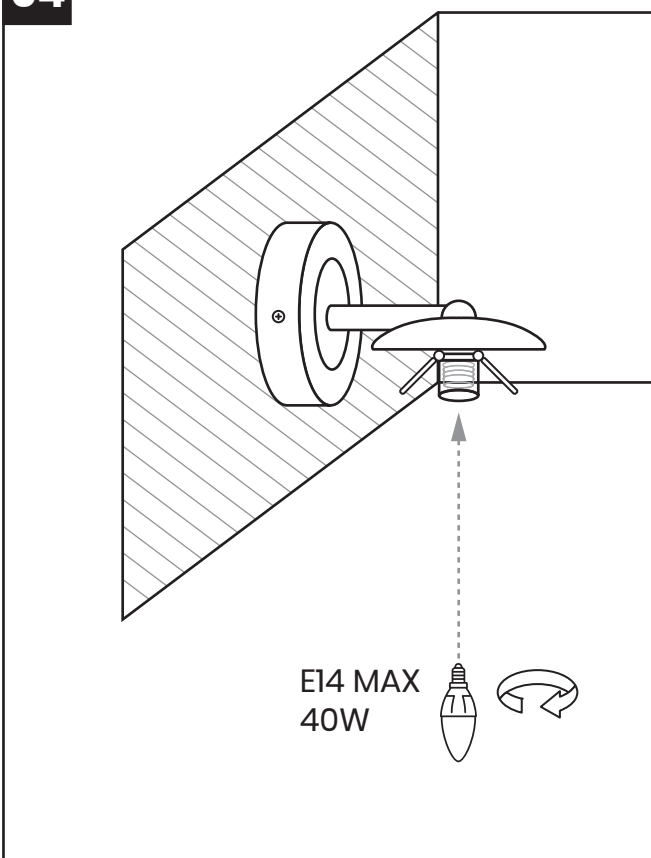

05

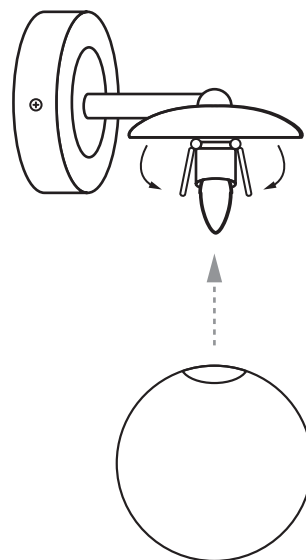

07

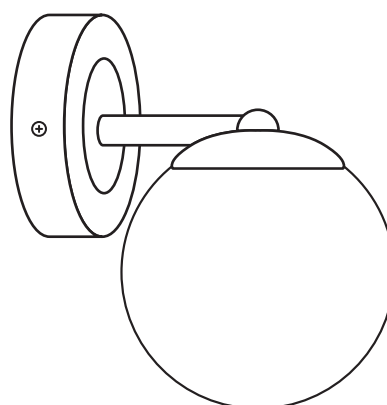

06

